



Samsung airconditioner technology achieves world-wide recognition

Comfort & Design Award 2008

Organised by Fiera Milano International, the Comfort & Design Award plays the role of intermediary between the Jury and companies participating in the Mostra Convegno Expocomfort/Expobagno. Aimed at rewarding products that display a high level of environmental quality, the Comfort & Design Award 2008 was conferred upon the Samsung MB airconditioner – professional recognition of its advanced eco-friendly technology.



iF Product Design Award 2009

As one of the world's oldest and most prestigious design competitions, the iF product design award has stood for qualitatively excellent design for over 50 years. Samsung's MB airconditioner with its many design innovations won the iF design award in 2009, proving yet again the superiority of Samsung technology.



Nationwide backing

Samsung's Digital Variable Multisystems are backed nationwide by the might of Samsung Air with branches in all major metropolitan areas. A dedicated Samsung Training Centre has also been established to train installers.

For more information on Samsung's DVM™ System, contact Samsung Air: _____

SAMSUNGair
www.samsungair.co.za

Gauteng & Central region
(011) 704-6320

Pretoria
(012) 661-2002

Western, Eastern & Northern Cape
(021) 556-8292

Kwa-Zulu Natal
(031) 579-1895



Due to Samsung's policy of constant improvement, specifications are subject to change without notice. E&OE

DVM
Digital Variable Multisystem



**Revolutionising
Aircon Installations
In South Africa**



- Samsung's Digital Variable Multisystem utilises Variable Refrigerant Flow technology to effect major electricity savings whilst R410A gas ensures eco-friendliness
- Ultra-reliable Copeland® Digital Scroll Compressor allows flexible modulation of capacity from 10% to 100%, providing rapid response to changing occupancy loads
- Multiple indoor units of various types – including splits, cassettes or ducteds – can be connected to a single outdoor unit
- Capacities from 4 HP Mini DVM to 64 HP (14kW - 179kW) with industry-leading EER and COP figures
- Long pipe runs to external condensing units contribute to aesthetic building design
- Supported nationwide by Samsung Air



From hotel chains and major banks to hospitals, office blocks, government buildings and upmarket residential applications – the swing is on to Samsung DVM™ (Digital Variable Multisystem)



When it comes to larger airconditioning projects, top of the list of requirements today are efficiency, eco-friendliness, electricity savings and aesthetics. Which is why Samsung's DVM Plus III system installations are sweeping South Africa! Not only do Samsung DVM systems provide superb economy of operation but also eco-friendliness along with ease of installation, individual temperature control and a wide choice of indoor units. Available in Heat Pump and also Heat Recovery versions.

Refrigerant Leakage Prevention

To prevent refrigerant leakage, Samsung provides a solution to diagnose any refrigerant leakage during product operation. Additionally, changing service valves from flange type to brazed type further prevents refrigerant leakage.





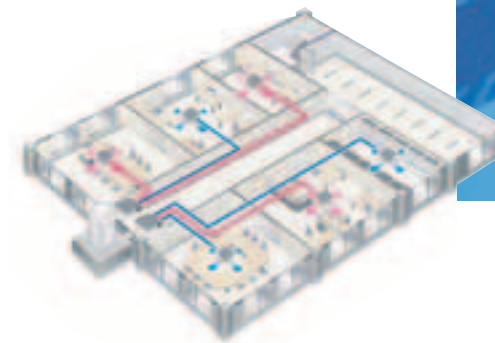

DVM PLUS III HR



The Samsung DVM Plus III is available in either 2-pipe version or, alternatively, 3-pipe Heat Recovery System. As the Plus III HR allows simultaneous cooling and heating operation with one system, it has a variety of applications:

- Plus III HR is ideal for environments where simultaneous cooling and heating operation is required e.g. hotels, guesthouses, nursing homes etc. In larger office blocks, DVM Plus III HR provides both heating and cooling operations simultaneously to satisfy requirements of interior and perimeter zones.
- In applications such as hotels, DVM Plus III also allows heat recovery from warmer rooms (e.g. those on the North side of the building) to be transferred via MCU boxes to cooler rooms, thus enabling an additional saving of electricity.

Model Line-Up	DVM PLUS III	RVXVHT080GE	RVXVHT100GE	RVXVHT120GE	RVXVHT140GE	RVXVHT160GE
	DVM PLUS III HR	RVXVRT080GE	RVXVRT100GE	RVXVRT120GE	RVXVRT140GE	RVXVRT160GE
Baseline *Combination of baseline can get up to 64HP						
	22.4kW	28kW	33.6kW	39kW	45kW	

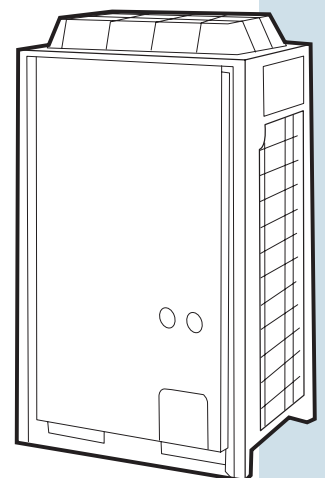



Advanced features that make the Samsung DVM Plus III a world-beater

Up to 64 HP Capacity

By combining up to 4 outdoor units, the Samsung DVM Plus III system achieves a capacity of 64 HP*. Many different combinations of heat pump or heat recovery type support up to 64 different indoor units, providing consumers with a variety of choices for any installation condition.



Smallest Footprint area

The DVM Plus III system is extremely compact, occupying a small footprint area of up to 32% less than conventional models, thus allowing installation in confined spaces.

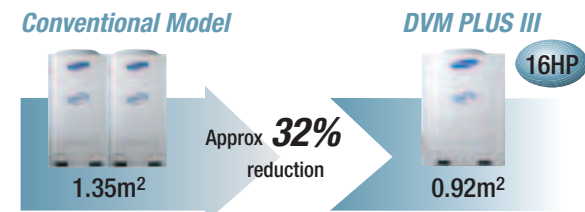

Model	12 HP	16 HP
Conventional Model	0.92m ²	1.35 m ²
DVM Plus III	0.67m ²	0.92 m ²
Comparison to Conventional Model	73%	68%
Space-saving %	27%	32%

Digital Hybrid System

DHS (Digital Hybrid System) is a brand new concept system composed of DVI compressor, vapour injection technology and turbo intercooler. These three factors combine to provide highly efficient performance.



Optimised Fan Guard

Optimised design enhances airflow volume to achieve high heat transfer with minimum noise.



Ø8 Heat Exchanger

Highly efficient Ø8 Heat Exchanger grooved tube reduces pressure loss while increasing heat transfer performance to improve COP.

New G-Fin

High-efficiency new G-fin improves heat transfer and corrosion resistance.

Turbo Intercooler

Turbo intercooler (Shell and Tube type) improves cooling and heating COP while enhancing reliability on long piping runs.

DVI Compressor

DVI (Digital Vapour Injection) compressor injects optimised mid-range pressure refrigerant to improve cooling/heating performance and economy of operation.

Economy of operation

To ensure maximum operating economy, Samsung's DVM™ outdoor units employ Digital Scroll Technology which allows flexible modulation of capacity from 10% to 100%. Thus if only one or two individual room airconditioners are in use, the DVM System operates at a fraction of its total capacity, effecting major savings in terms of electricity.

Capacities from 4 HP to 64 HP

From a 4 HP Mini-DVM (14kW) system up to a combination of outdoor units delivering 64 HP (179kW), Samsung's DVM range covers a wide variety of applications.

Ecofriendliness

Samsung's DVM Plus III System is an eco-friendly product that utilises lead-free indoor and outdoor PC boards to prevent pollution problems caused by the use of lead. It also uses R410A gas.



High COP

High-efficiency DVM Plus III has improved average cooling and heating COP compared to conventional airconditioners, achieving world Top Class energy efficiency.

Extreme Versatility

A permissible pipe length of up to 220 metres between the outdoor and indoor units combined with a total of up to 50 metres difference in height between indoor and outdoor units ensures maximum installation flexibility. Total piping length: 1000m. The result is ultimate convenience in terms of positioning the outdoor unit for an aesthetically-pleasing solution.

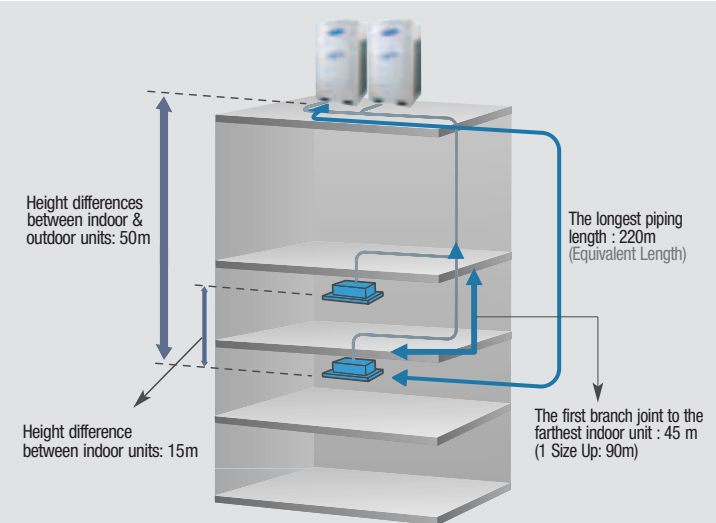

Individual temperature control

While one outdoor unit supplies multiple indoor units, Samsung's DVM™ System permits individual temperature control within each office, allowing the occupants to select their own preferred room temperature.



Vapour Injection Technology

Industry-leading cooling/heating performance and COP is achieved in the DVM Plus III by a new technology of two-stage compression. Vapour Injection Technology results in increased refrigerant flow rates as well as improved sub-cooling necessary for long piping runs.

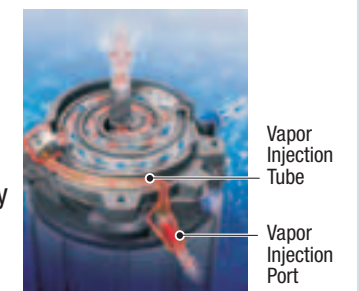

Samsung's Digital Variable Multisystem enables a wide variety of Indoor Units to be used

Choice of Indoor Units and Control Systems

Samsung's outdoor DVM™ unit can be linked to a variety of different indoor units: Midwall splits, Ceiling Cassette units, Ducted units etc. Control systems range from wired remotes to complete Building Management Systems.

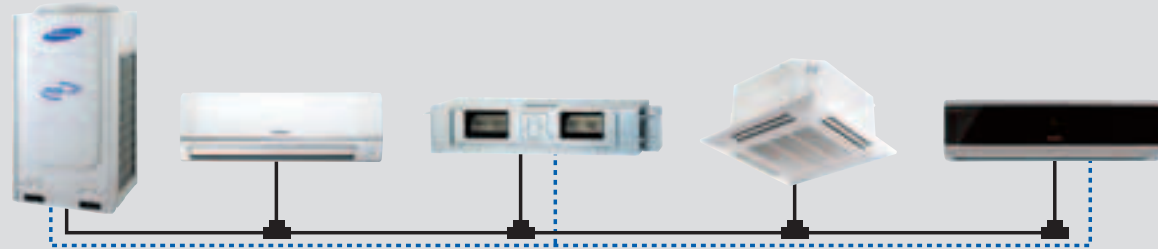

External Static Pressure

In order to respond to a variety of installation environments (e.g. outdoor units installed within a roof space) Samsung's DVM Plus III is designed to be used up to an external static pressure of 80 pascals, thus facilitating ducting.

Ease of installation

Modern technology simplifies installation procedures, making DVM units easy to install.

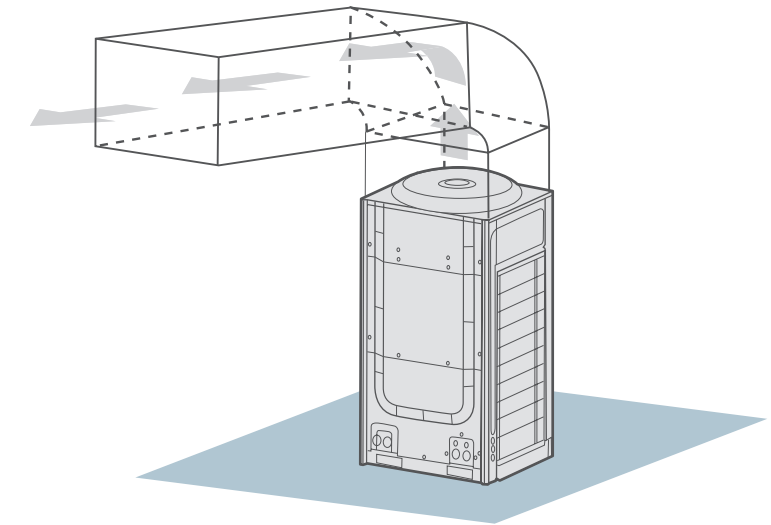

		Capacity	7K Btu/h 2.2 kW	9K Btu/h 2.8 kW	12K Btu/h 3.6 kW	15K Btu/h 4.5 kW	18K Btu/h 5.6 kW	21K Btu/h 6.0 kW	24K Btu/h 7.1 kW	30K Btu/h 9.0 kW	36K Btu/h 11.2 kW	44K Btu/h 12.8 kW	48K Btu/h 14.0 kW
		Type											
Wall-mounted Type	MB												
	Vivace												
	Neo Forte												
Cassette Type	Slim 1Way												
	2Way Cassette												
	Mini 4Way Cassette												
	4Way Cassette												
Duct Type	Slim Duct												
	M.S.P Duct												
Floor & Convertible Type	Console												
	Ceiling												